



# Monitoring Report

CARBON OFFSET UNIT (CoU) PROJECT



**Title:** 18 MW solar Power plant in Karnataka M/s Asian Fab Tec Limited.

Version 2.0

Date 23/07/2024

First CoU Issuance Period: 7 years, 00 months

Monitoring Period: 01/01/2017 to 31/12/2023



**Monitoring Report (MR)  
CARBON OFFSET UNIT (CoU) PROJECT**

Monitoring Report	
Title of the project activity	18 MW Solar Power Plants in Karnataka M/s Asian Fab Tec Limited.
UCR Project Registration Number	438
Version	02
Completion date of the MR	23/07/2024
Monitoring period number and duration of this monitoring period	Monitoring Period Number:01 Duration of this monitoring Period: (first and last days included (1/01/2017 to 31/12/2023)
Project participants	M/s Asian Fab Tec Limited
Host Party	India
Applied methodologies and standardized baselines	ACM0002: Grid-connected electricity generation from renewable sources version 21
Sectoral scopes	01 Energy industries (Renewable/Non -Renewable Sources)
Estimated amount of GHG emission reductions for this monitoring period in the registered PCN	2017: 32,114 CoUs 2018:27,037CoUs 2019:26,150 CoUs 2020 :24,494CoUs 2021 :23,753 CoUs 2022: 23,508CoUs 2023: 25,845 CoUs
<b>Total:</b>	<b>1,82,901CoUs (1,82,901tCO<sub>2</sub>eq)</b>

## SECTION A. Description of project activity

### A.1. Purpose and general description of project activity >>

#### a) Purpose of the project activity and the measures taken for GHG emission reductions >>

The project activity titled ,18 MW Solar Power Plants in Karnataka M/s Asian Fab Tec Limited. located in Village Bevinahalli , Tehsil sira, District Tumkur, State Karnataka, Country India.

The details of the registered project are as follows:

Company Name	Plant Capacity(MW)	Location	Commissioning Date
Asian Fab Tec Limited	3	Village Bevinahalli ,	23/12/2016
	5	Tehsil sira, District	23/12/2016
	10	Tumkur ,state Karnataka	11/01/2017

The power produced by the 3MW, 5MW and 10MW is evacuated at the Bevinahalli 11/66 KV Substation located at Village Bevinahalli , Tehsil sira, District Tumkur, State Karnataka

The generation of power from solar photovoltaics is a clean technology as there is no fossil fuel-fired or no GHG gases are emitted during the process. A photovoltaic module consists of several photovoltaic cells connected by circuits and sealed in an environmentally Protective laminate, which forms the fundamental building blocks of the complete PV generating unit. Several PV panels mounted on a frame are termed PV Array. Thus, project activity leads to a reduction the GHG emissions as it displaces power from fossil fuel-based electricity generation in the regional grid. Since the project activity generates electricity through solar energy, a clean renewable energy source it will not cause any negative impact on the environment and thereby contributes to climate change mitigation efforts.

The project replaces anthropogenic emissions of greenhouse gases (GHGs) 1,82,901 tCO<sub>2</sub>e there on displacing 2,03,227.63MWh amount of electricity from the generation mix of power plants connected to the Indian electricity grid, which is mainly dominated by the thermal / fossil fuel based power plant. he project activity is the installation of a new grid connected renewable power plant/unit. The scenario existing prior to the implementation of the project activity is electricity delivered to the grid by the project activity would have otherwise been generated by the operation of grid connected power plants and by the addition of new generation sources. Baseline scenario and scenario existing prior to the implementation of the project activity are both same.

#### b) Brief description of the installed technology and equipment>>

The project activity is using clean renewable solar energy to produce electricity. The applied technology is considered to be one of the most environment friendly technologies available as the operation of the Solar photovoltaic does not emit any GHGs or any other harmful gases unlike the operation of conventional power plants.

The Project Activity is a new facility (Greenfield) and the electricity generated by the project is exported to the national grid of India to be purchased by Chamundeshwari Electricity Supply Company Ltd (CESCOM) and Bangalore Electricity Supply Company Ltd (BESCOM).

The project activity displaces an equivalent amount of electricity which would have otherwise been generated by fossil fuel dominant electricity grid. The estimated lifetime of the project activity is considered as 25 years for solar technology. In the Pre- project scenario the entire electricity, consumed by the customers or delivered to the grid by, would have otherwise been generated by the operation of grid-connected power plants and by the addition of new generation sources.

### **Technology used in Project Activity**

The main components include:

**Solar PV modules:** – Solar PV modules convert solar radiation directly into electricity through the photovoltaic effect in a silent and clean process that requires no moving parts. The photovoltaic effect is a semiconductor effect whereby solar radiation falling onto the semiconductor PV cells generates electron movement. The output from a solar PV cell is direct current (DC) electricity. A PV power plant contains many cells connected together in modules and many modules connected together in strings to produce the required DC power output.

**Inverters** – Invertors are required to convert the DC electricity to alternating current (AC) for connection to the utility grid. Many modules in series strings and parallel strings are connected to the inverters

**Step-up transformers:** – The output from the inverters generally requires a further step-up in voltage to reach the AC grid voltage level. The step-up transformer takes the output from the inverters to the required grid voltage (33 kV)

**Module mounting systems:** Fixed mounting systems keep the rows of modules at a fixed tilt angle while facing a fixed angle of orientation for maximising the energy incident on the collector plane. The optimum tilt angle is generally between 10° and 35°, facing true south.

Parameter	Specification		
Project Capacity	3MW	5MW	10MW
Irradiation details considered	2173Kwh/Sqm	2173kWh/sqm.	2173 kWh/sqm
Make of PV module	Premier	Premier	Premier
Type of system	Fixed Tilt structure.	Fixed Tilt Structure	Fixed Tilt Structure
Project Capacity	3 MW AC ~ 3.48 MWp DC	5 MW AC ~ 5.8 MWp DC	10 MW AC ~ 11.712 MWp DC
Invertor Make	ABB PVS-800	ABB PVS-800	ABB PVS-800
Invertor rating	1000kW/Units	1000kW/Unit	1000 kW / unit - total 10 units
Number of Invertor	3	5	10
Capacity of Module	310Wp	310Wp	310Wp
Tilt angle	5°/25° facing south seasonal tilt	5°/25° facing south seasonal tilt	5°/25° facing south seasonal tilt
Transformer Make	Essenar	Essenar	Essenar
Transformer details	3.0 MVA Three winding	1.0 MVA Three Winding	2.0 MVA Three Winding

	transformer, 0.400/33KV Stepup	Transformer and two -2.0 MVA Three Winding Transformer	Transformer, 0.270/33KV Stepup
Number of Transformer	1	3	5
Efficiency of Panels	14.50%	14.50%	14.50%
Type of Mounting Structure	Seasonal Tilt	Seasonal Tilt	Seasonal Tilt
Power Conditioning Unit Make	ABB-PVS500	ABB-PVS500	ABB-PVS500
Power Conditioning Unit	1000 kW	500kW	500kW
Number of PCU	3	20	20
Expected life of Power Plant	25 year	25 years	25 years

c) Relevant dates for the project activity (e.g. construction, commissioning, continued operation periods, etc.)>>

UCR Project ID or Date of Authorization: 438  
 Start Date of Crediting Period: 01/01/2017  
 Start date of this Monitoring Period:01/1/2017  
 Project Commissioned details are given below:

Plant Capacity(MW)	Location	Commissioning Date
3	Village Bevinahalli ,	23/12/2016
5	Tehsil sira, District	23/12/2016
15	Tumkur ,state Karnataka	11/01/2017

d) Total GHG emission reductions achieved or net anthropogenic GHG removals by sinks achieved in this monitoring period>>

The total GHG emission reductions achieved in this monitoring period is as follows:

<b>Summary of the Project Activity and ERs Generated for the Monitoring Period</b>	
Start date of this Monitoring Period	01/01/2017.
Carbon credits claimed up to	31/12/2023
Total ERs generated (tCO <sub>2</sub> eq)	1,82,901 tCO <sub>2</sub>
Leakage	0

e) Baseline Scenario>>

The baseline scenario identified at the PCN stage of the project activity is:

The scenario existing prior to the implementation of the project activity, is electricity delivered to the facility by the project activity that would have otherwise been generated by the operation of grid

connected power plants and by the addition of new generation sources. This is a green field project activity. There was no activity at the site of the project participant prior to the implementation of this project activity. Hence pre-project scenario and baseline scenario are the same.

As per the approved consolidated methodology ACM0002 Version 21, if the project activity is the installation of a new grid-connected renewable power plant/unit, the baseline scenario is the following: “If the project activity is the installation of a Greenfield power plant, the baseline scenario is electricity delivered to the grid by the project activity would have otherwise been generated by the operation of grid-connected power plants and by the addition of new generation sources to the grid”.

Schematic diagram showing the baseline scenario:

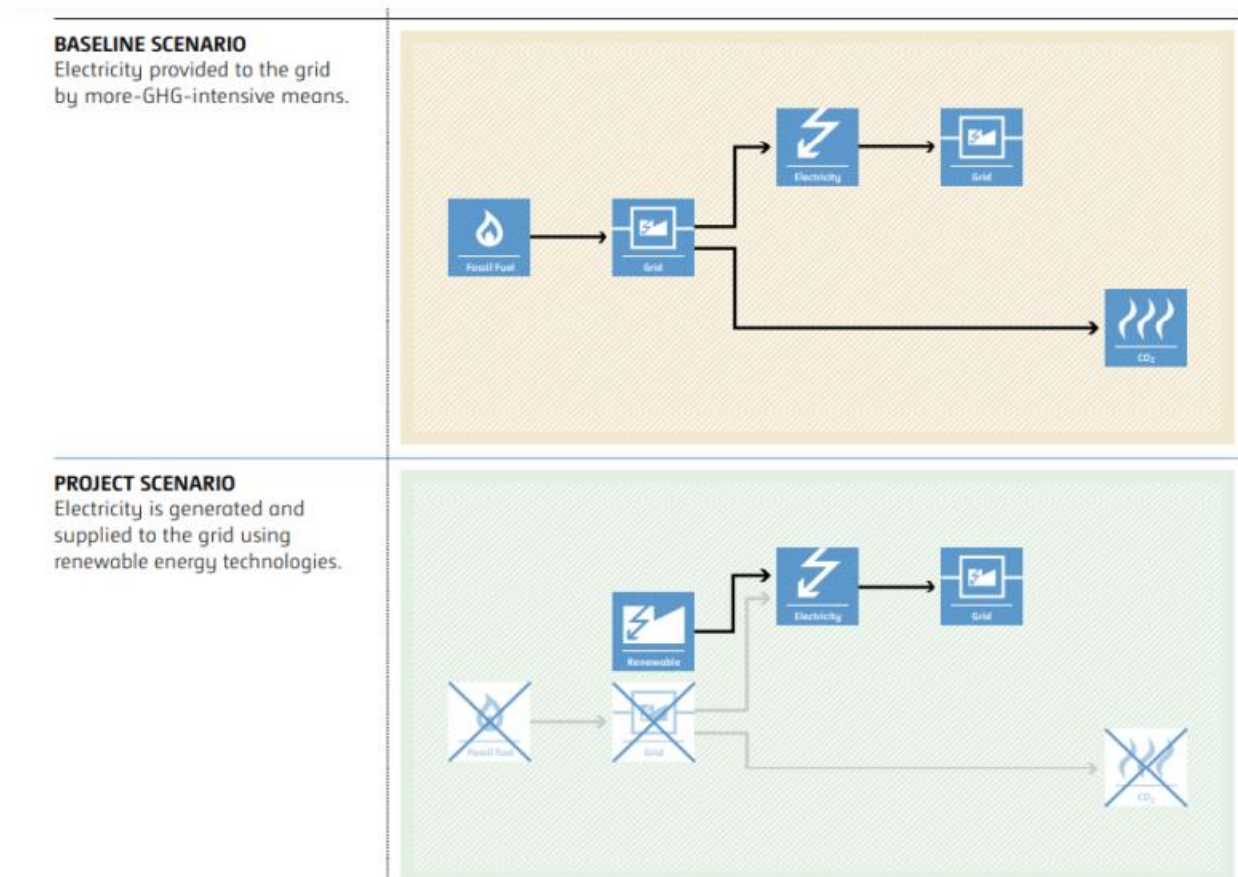

#### A.2. Location of project activity>>>

Country: India  
 District: Tumkur  
 Village: Bevinahalli  
 Tehsil: sira  
 State: Karnataka.

The geographic co-ordinates of the project location have been given below:

Latitude : 13°54'38.1"N  
 Longitude : 76°49'16.0"E

The representative Location of map is included below:

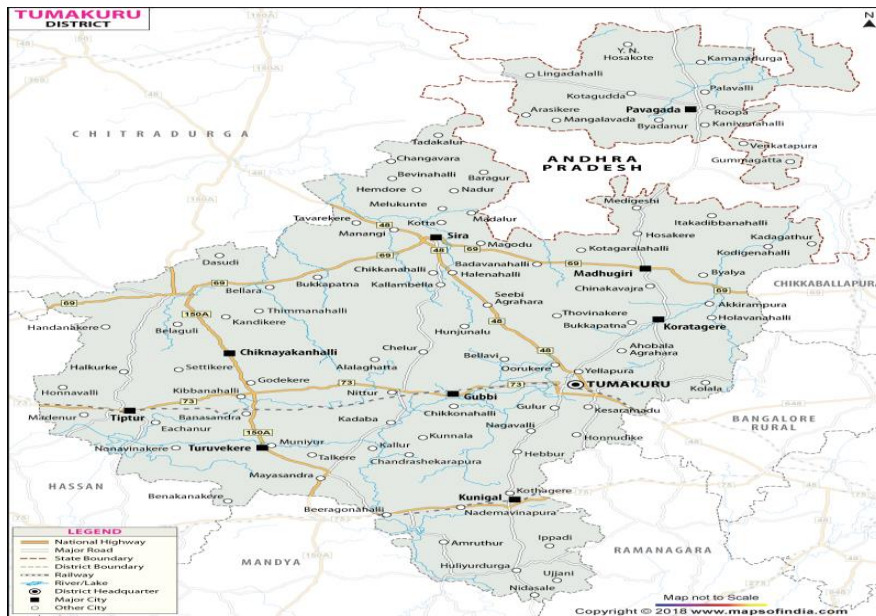

Project Activity





### A.3. Parties and project participants >>

Party (Host)	Participants
India	M/s Asian Fab Tec Limited

### A.4. References to methodologies and standardized baselines >>

#### SECTORAL SCOPE:

01, Energy industries (Renewable/Non-renewable sources)

#### TYPE :

I - Renewable Energy Projects

CATEGORY: ACM0002: Grid-connected electricity generation from renewable sources Version 21.0

The project activity involves generation of grid connected electricity from the construction and operation of a new solar power project activity has installed capacity of 18 MW which will qualify for a Large scale project activity. The project status is corresponding to the methodology ACM0002 version 21 and applicability of methodology is discussed below:

### A.5. Crediting period of project activity >>

Length of the crediting period corresponding to this monitoring period:7 years 00 Months– 01/01/2017 -31/12/2023((Both dates are inclusive)

### A.6. Contact information of responsible persons/entities >>

Contact Person: Lokesh Jain

Mobile:+91-8920856146

Email: lokesh.jain@viviidgreen.com

Address: Sri Krishna Complex, New Link Road, Opp. Laxmi Industrial Estate, Andheri (West), Mumbai - 400053

## SECTION B. Implementation of project activity

### B.1. Description of implemented registered project activity >>

a) Provide information on the implementation status of the project activity during this monitoring period in accordance with UCR PCN>>

The project consists of ground mounted photo voltaic solar plant with aggregated installed capacity of 18 MW. The plant was commissioned on several dates by the respective authority of government of Karnataka The project generates clean energy by utilizing the solar Radiations

The applied technology is considered to be one of the most environment friendly technologies available as the operation of the Solar photovoltaic does not emit any GHGs or any other harmful gases unlike the operation of conventional power plants. Photovoltaic module consists of several photovoltaic cells connected by circuits and sealed in an environmentally protective laminate, which forms the fundamental building blocks of the complete PV generating unit. Several PV panels mounted on a frame are termed as PV Array.

The project activity has used the reliable and proven technology to ensure that an environmentally safe and sound technology has been implemented.

Figure below gives an overview of a megawatt scale grid-connected solar PV power plant:

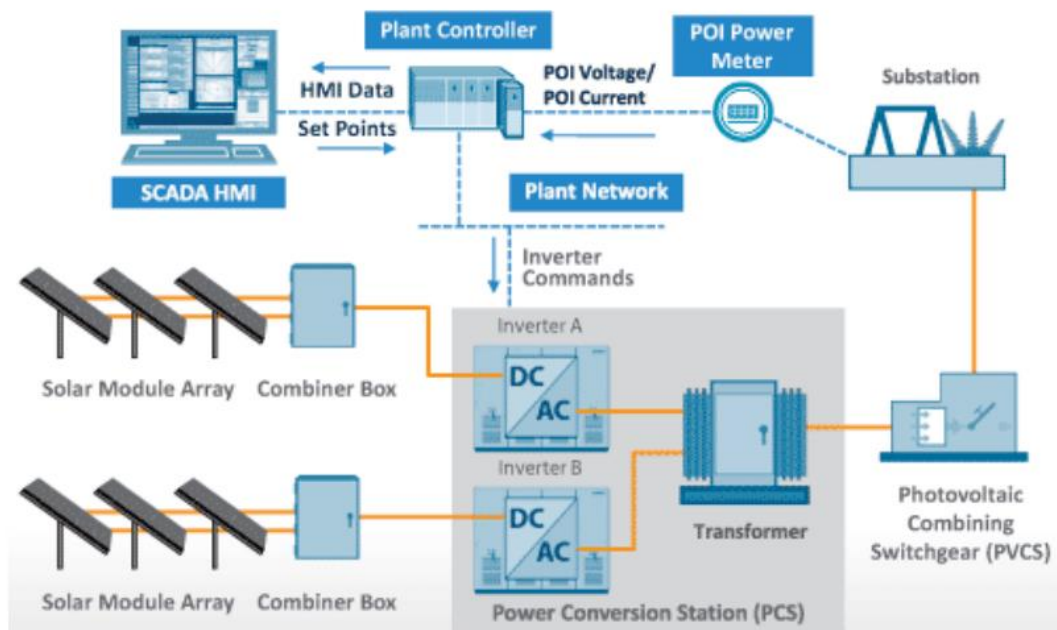

b) For the description of the installed technology(ies), technical process and equipment, include diagrams, where appropriate>>

### Technology used in Project Activity

The main components include:

**Solar PV modules:** – Solar PV modules convert solar radiation directly into electricity through the photovoltaic effect in a silent and clean process that requires no moving parts. The photovoltaic effect is a semiconductor effect whereby solar radiation falling onto the semiconductor PV cells generates electron movement. The output from a solar PV cell is direct current (DC) electricity. A PV power plant contains many cells connected together in modules and many modules connected together in strings to produce the required DC power output.

**Inverters** – Inverters are required to convert the DC electricity to alternating current (AC) for connection to the utility grid. Many modules in series strings and parallel strings are connected to the inverters

**Step-up transformers:** – The output from the inverters generally requires a further step-up in voltage to reach the AC grid voltage level. The step-up transformer takes the output from the inverters to the required grid voltage (33 kV)

**Module mounting systems:** Fixed mounting systems keep the rows of modules at a fixed tilt angle while facing a fixed angle of orientation for maximising the energy incident on the collector plane. The optimum tilt angle is generally between 10° and 35°, facing true south.

## **B.2 Do no harm or Impact test of the project activity>>**

There are social, environmental, economic and technological benefits which contribute to sustainable development.

This project is a greenfield activity where grid power is the baseline. Indian grid system has been predominantly dependent on power from fossil fuel powered plants. The renewable power generation is gradually contributing to the share of clean & green power in the grid; however, grid emission factor is still on higher side which defines grid as distinct baseline.

There was no harm identified from the project and hence no mitigation measures are applicable. Rational: as per ‘Central Pollution Control Board (Ministry of Environment & Forests, Govt. of India)’, the final document on the revised classification of Industrial Sectors under Red, Orange, Green, and White Categories (07/03/2016), it has been declared that Solar project activity falls under the “White category”. White Category projects/industries do not require any Environmental Clearance such as ‘Consent to Operate’ from PCB as such project does not lead to any negative environmental impacts. Additionally, as per Indian regulations, Environmental and Social Impact Assessment is not required for Solar Projects. Additionally, there are social, environmental, economic, and technological benefits that contribute to sustainable development. The key details have been discussed below:

- **Social benefits:**
- The project activity will lead to the development of supporting infrastructure such as road network etc., in the solar park location, the access to which is also provided to the local population.
- The project will create job opportunities for local residents, both temporary during construction and permanent during operation. This will boost income and improve the standard of living in the community.
  
- **Economic benefits:**
- The project activity requires temporary and permanent, skilled and semi-skilled manpower at the Solar park; this will create additional employment opportunities in the region.

- The generated electricity will be fed into the regional grid through local grid, thereby improving the grid frequency and availability of electricity to the local consumers (villagers & sub-urban habitants) which will provide new opportunities for industries and economic activities to be setup in the area thereby resulting in greater local employment, ultimately leading to overall development.
- **Technical benefits:**
- The project activity is step forward in harnessing the untapped solar potential technology in the region. The project activity leads to the promotion and demonstrates the success of solar projects in the region which further motivate more investors to invest in solar power projects. Hence, the project activity leads to technological well-being.
- **Environmental benefits:**
- The project activity employs renewable energy source for electricity generation instead of fossil fuel-based electricity generation which would have emitted gaseous, liquid and/or solid effluents/wastes.
- Being a renewable resource, using solar energy to generate electricity contributes to resource conservation. Thus, the project causes no negative impact on the surrounding environment and contributes to environmental well-being.

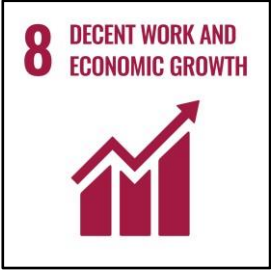
SDG Goals	Description
<p data-bbox="284 943 376 972">Goal 7</p> 	<ul style="list-style-type: none"> <li>➤ The project activity will generate clean energy, which with increased shared will increase the affordability at a cheaper rate to end user. The project activity will utilize solar energy (renewal resource) to generate power. The project activity will increase the share of renewable resource-based electricity to global mix of energy consumption</li> </ul>
<p data-bbox="284 1308 376 1337">Goal 8</p> 	<ul style="list-style-type: none"> <li>➤ Decent work and economic growth. This project activity generates additional employment for skilled and unskilled, also the project situated in remote area will provide employment opportunities to unskilled people from villages. The training on various aspect including safety, operational issues and developing skill set will also be provided to employees</li> <li>➤ This project will achieve full and productive employment and decent work.</li> </ul>
<p data-bbox="268 1928 392 1957">Goal 13</p>	<ul style="list-style-type: none"> <li>➤ This 18 MW Solar power project meet the SDG 13 goal by saving fossil fuel and produce clean energy. This project is expected to reduce <b>1,82,901</b> tCO<sub>2</sub> for this monitoring period.</li> </ul>

**13** CLIMATE  
ACTION



- In a Greenfield project, electricity delivered to the grid by the project would have otherwise been generated by the operation of grid connected power plants. Thereby the project activity reduces the dependence on fossil fuel-based generation units and as there are no associated emissions with this project it contributes to the reduction of greenhouse gases (GHG) emissions.

### B.3. Baseline Emissions>>

The baseline scenario identified at the PCN stage of the project activity is:

The scenario existing prior to the implementation of the project activity, is electricity delivered to the facility by the project activity that would have otherwise been generated by the operation of grid connected power plants and by the addition of new generation sources. This is a green field project activity. There was no activity at the site of the project participant prior to the implementation of this project activity. Hence pre-project scenario and baseline scenario are the same.

As per the approved consolidated methodology ACM0002 Version 21, if the project activity is the installation of a new grid-connected renewable power plant/unit, the baseline scenario is the following: “If the project activity is the installation of a Greenfield power plant, the baseline scenario is electricity delivered to the grid by the project activity would have otherwise been generated by the operation of grid-connected power plants and by the addition of new generation sources to the grid”.

#### BASELINE SCENARIO

Electricity provided to the grid by more-GHG-intensive means.

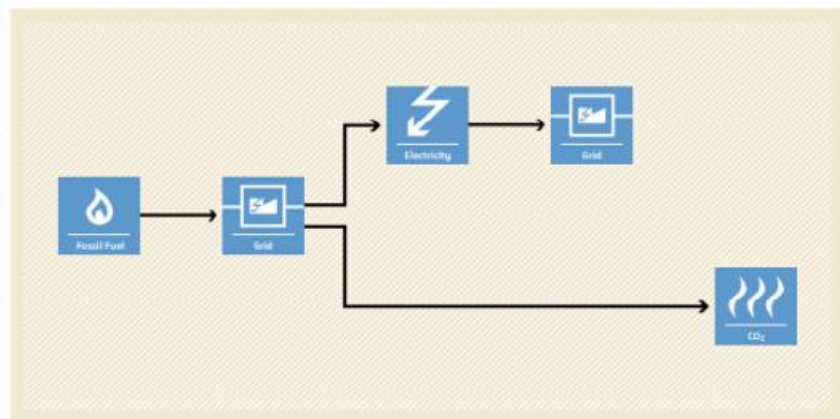

#### PROJECT SCENARIO

Electricity is generated and supplied to the grid using renewable energy technologies.

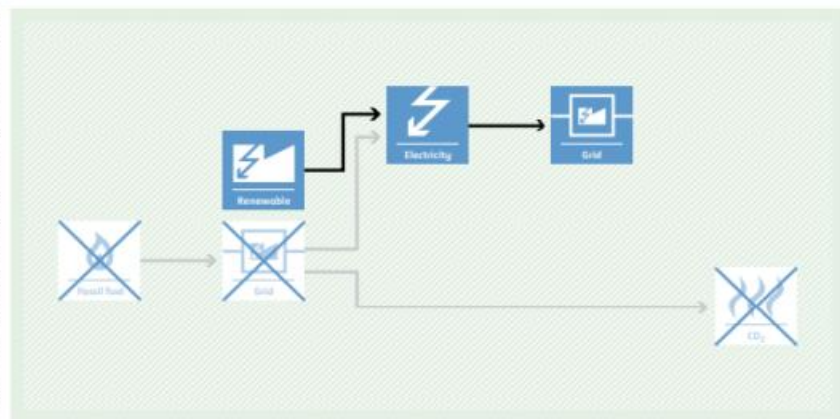

### B.4. Debundling>>

This project is not a De-bundled component of a larger project activity.

## SECTION C. Application of methodologies and standardized baselines

### C.1. References to methodologies and standardized baselines >>

#### SECTORAL SCOPE:

01, Energy industries (Renewable/Non-renewable sources)

#### TYPE :

I - Renewable Energy Projects

CATEGORY: ACM0002: Grid-connected electricity generation from renewable sources  
- Version 21.0

### C.2. Applicability of methodologies and standardized baselines >>

The project activity involves generation of grid connected electricity from the construction and operation of a new solar power project activity has installed capacity of 18 MW which will qualify for a Large scale project activity. The project status is corresponding to the methodology ACM0002 version 21 and applicability of methodology is discussed below:

<b>Applicability Criteria.</b>	<b>Applicability status</b>
<p>1) This methodology is applicable to grid-connected renewable energy power generation project activities that:</p> <ul style="list-style-type: none"> <li>(a) Install a Greenfield power plant;</li> <li>(b) Involve a capacity addition to (an) existing plant(s);</li> <li>(c) Involve a retrofit of (an) existing operating plant(s)/unit(s);</li> <li>(d) Involve a rehabilitation of (an) existing plant(s)/unit(s); or</li> <li>(e) Involve a replacement of (an) existing plant(s)/unit(s).</li> </ul>	<p>The proposed project activity is a green field, grid connected renewable solar power plant. Therefore, it confirms to the said criteria</p>
<p>2) In case the project activity involves the integration of a BESS, the methodology is applicable to grid-connected renewable energy power generation project activities that:</p> <ul style="list-style-type: none"> <li>(a) Integrate BESS with a Greenfield power plant;</li> <li>(b) Integrate a BESS together with implementing a capacity addition to (an) existing solar photovoltaic or wind power plant(s)/unit(s);</li> <li>(c) Integrate a BESS to (an) existing solar photovoltaic or wind power plant(s)/unit(s) without implementing any other changes to the existing plant(s);</li> <li>(d) Integrate a BESS together with implementing a retrofit of (an) existing solar photovoltaic or wind power plant(s)/unit(s).</li> </ul>	<p>The project activity is the installation of a new grid connected renewable solar power project and does not involve the integration of a Battery Energy Storage System (BESS). This condition is not applicable for the project activity</p>
<p>3) The methodology is applicable under the following conditions:</p> <ul style="list-style-type: none"> <li>(a) Hydro power plant/unit with or without reservoir, wind power plant/unit, geothermal power plant/unit, solar power plant/unit, wave power plant/unit or tidal power plant/unit;</li> <li>(b) In the case of capacity additions, retrofits, rehabilitations or replacements (except for wind, solar, wave or tidal power capacity addition projects) the existing plant/unit started commercial operation prior to the start of a minimum historical reference period of five years, used for the calculation of baseline emissions and defined in the baseline emission section, and no capacity expansion, retrofit, or rehabilitation of the plant/unit has been undertaken between the start of this minimum historical reference period and the implementation of the project activity;</li> <li>(c) In case of Greenfield project activities applicable under paragraph 5 (a) above, the project participants shall demonstrate that the BESS was an integral part of the design of the renewable energy project activity (e.g. by referring to feasibility studies or investment decision documents);</li> <li>(d) The BESS should be charged with electricity generated from the associated renewable energy power plant(s). Only during exigencies 2 may the BESS be charged with electricity from the grid or a fossil fuel electricity generator. In such cases, the corresponding GHG emissions shall be accounted for as project</li> </ul>	<p>The proposed project activity is the installation of a new solar power plants without BESS integration. Therefore, the said criterion is not applicable</p>



<p>emissions following the requirements under section 5.4.4 below. The charging using the grid or using fossil fuel electricity generator should not amount to more than 2 per cent of the electricity generated by the project renewable energy plant during a monitoring period. During the time periods (e.g. week(s), months(s)) when the BESS consumes more than 2 per cent of the electricity for charging, the project participant shall not be entitled to issuance of the certified emission reductions for the concerned periods of the monitoring period.</p>	
<p>4) In case of hydro power plants, one of the following conditions shall apply:</p> <p>a) The project activity is implemented in an existing single or multiple reservoirs, with no change in the volume of any of reservoirs; or</p> <p>b) The project activity is implemented in an existing single or multiple reservoirs, where the volume of the reservoir(s) is increased and the power density calculated using equation (7) is greater than 4 W/m<sup>2</sup>; or</p> <p>c) The project activity results in new single or multiple reservoirs and the power density calculate equation (7), is greater than 4 W/m<sup>2</sup>.</p> <p>d) The project activity is an integrated hydro power project involving multiple reservoirs, where the power density of any of the reservoirs, calculated using equation (7), is lower than or equal to 4 W/m<sup>2</sup>, all of the following conditions shall apply.</p> <p>i) The power density calculated using the total installed capacity of the integrated project, as per equation (8) is greater than 4W/m<sup>2</sup>;</p> <p>ii) Water flow between reservoirs is not used by any other hydropower unit which is not a part of the project activity; Installed capacity of the power plant(s) with power density lower than or equal to 4 W/m<sup>2</sup> shall be: Lower than or equal to 15 MW; and Less than 10% of the total</p> <p>iii) installed capacity of integrated hydro power project</p>	<p>The proposed project activity is the installation of solar power plants/units. Therefore, the said criteria is not applicable.</p>
<p>5) In the case of integrated hydro power projects, project proponent shall:</p> <p>a) Demonstrate that water flow from upstream power plants/units spill directly to the downstream reservoir and that collectively constitute to the generation capacity of the integrated hydro power project; or</p> <p>b) Provide an analysis of the water balance covering the water fed to power units, with all possible combinations of reservoirs and without the construction of reservoirs. The purpose of water balance is to demonstrate the requirement of specific combination of reservoirs constructed under CDM project</p>	<p>The proposed project activity is the installation of a solar power plants/units. Therefore, the said criteria is not applicable</p>

<p>activity for the optimization of power output. This demonstration has to be carried out in the specific scenario of water availability indifferent seasons to optimize the water flow at the inlet of power units. Therefore this water balance will take into account seasonal flows from river, tributaries (if any), and rainfall for minimum five years prior to implementation of CDM project activity.</p>	
<p>6)The methodology is not applicable to:  a)Project activities that involve switching from fossil fuels to renewable energy sources at the site of the project activity, since in this case the baseline may be the continued use of fossil fuels at the site;  b)Biomass fired power plants;</p>	<p>The proposed project activity is the installation of solar power plants/units. Therefore, the said criteria is not applicable</p>
<p>7)In the case of retrofits, rehabilitations, replacements, or capacity additions, this methodology is only applicable if the most plausible baseline scenario, as a result of the identification of baseline scenario, is “the continuation of the current situation, that is to use the power generation equipment that was already in use prior to the implementation of the project activity and undertaking business as usual maintenance</p>	<p>The proposed project activity is the installation of solar power plants/units. Therefore, the said criteria is not applicable.</p>

### **C.3 Applicability of double counting emission reductions >>**

There is no double accounting of emission reductions in the project activity due to the following reasons:

- Project is uniquely identifiable based on its location coordinates,
- Project has dedicated commissioning certificate and connection point,
- Project is associated with energy meters which are dedicated to the consumption point for project developer

### **C.4. Project boundary, sources and greenhouse gases (GHGs)>>**

According to the methodology, the spatial extent of the project boundary includes the project power plant/unit and all power plants/units connected physically to the electricity system that the project power plant is connected to. Hence, the project boundary includes the project site where the power plant has been installed, associated power evacuation infrastructure, energy metering points, switch yards and other civil constructs and the connected national grid of India.

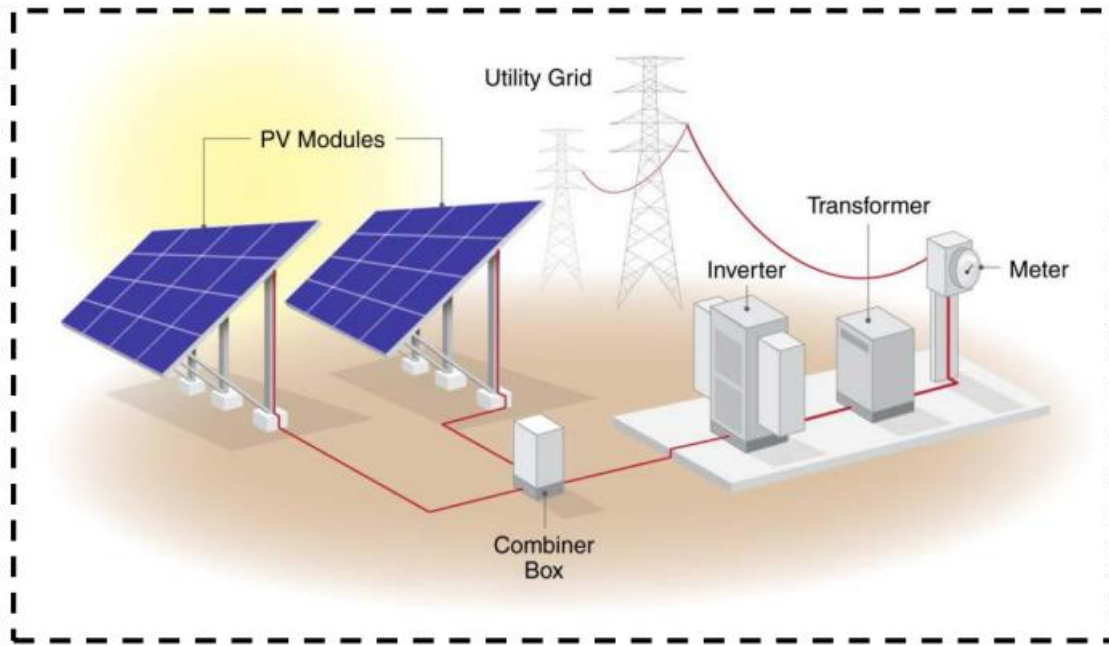

11

### Project Boundary

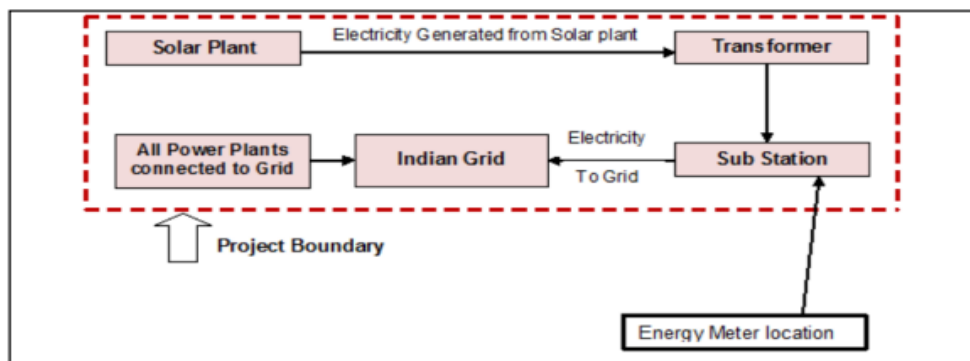

The table below provides an overview of the emissions sources included or excluded from the project boundary for determination of baseline and project emissions.

	Source	GHG	Included?	Justification/Explanation
Baseline	CO <sub>2</sub> emissions from electricity generation in grid-connected power plants that are displaced due to the project activity	CO <sub>2</sub>	Yes	Major source of emission
		CH <sub>4</sub>	No	Minor source of emission
		N <sub>2</sub> O	No	Excluded for simplification. This emission source is assumed to be very small
Project Activity	Emissions from on-	CO <sub>2</sub>	No	The quantity of electricity delivered to the project plant/unit from the grid has

	site electricity use in the project activity			been deducted from the quantity of electricity supplied by the project plant/unit to the grid when calculating the baseline emission, hence onsite electricity use in the project does not need to be considered as project emission
		CH <sub>4</sub>	No	Excluded for simplification. This emission source is assumed to be very small
		N <sub>2</sub> O	No	Excluded for simplification. This emission source is assumed to be very small

### C.5. Establishment and description of baseline scenario (UCR Protocol) >>

As per the approved consolidated methodology ACM0002. version - 21, if the project activity is the installation of a new grid-connected renewable power plant/unit, the baseline scenario is the following:

“The baseline scenario is that the electricity delivered to the grid by the project activity would have otherwise, been generated by the operation of grid-connected power plants and by the addition of new generation sources into the grid”

The project activity involves setting up of a new grid connected solar power plant to harness the green power from solar energy. In the absence of the project activity, the equivalent amount of power would have been supplied by the Indian grid, which is fed mainly by fossil fuel fired plants. The power produced at grid from the other conventional sources which are predominantly fossil fuel based. Hence, the baseline for the project activity is the equivalent amount of power produced at the Indian grid.

A "grid emission factor" refers to a CO<sub>2</sub> emission factor (tCO<sub>2</sub>/MWh) which will be associated with each unit of electricity provided by an electricity system. The UCR recommends an emission factor of 0.9 tCO<sub>2</sub>/MWh for the 2013-2020 years as a fairly conservative estimate for Indian projects not previously verified under any GHG program. Also, for the vintage 2021, the combined margin emission factor calculated from CEA database in India results into higher emission than the default value. Hence, the same emission factor has been considered to calculate the emission reduction under conservative approach.

As per approved consolidated methodology ACM0002, version 21.0, emission reduction is estimated as difference between the baseline emission and project emission after factoring into leakage

#### Emission Reduction:

<sup>1</sup> [https://a23e347601d72166dcd6-16da518ed3035d35cf0439f1cdf449c9.ssl.cf2.rackcdn.com/Documents/UCRCoUStandardAug2022updatedVer6\\_09082220127104470.pdf](https://a23e347601d72166dcd6-16da518ed3035d35cf0439f1cdf449c9.ssl.cf2.rackcdn.com/Documents/UCRCoUStandardAug2022updatedVer6_09082220127104470.pdf)

Thus,  $ER_y = BE_y - PE_y - LE_y$

Where:

$ER_y$  : Emission reductions in year y (tCO<sub>2</sub>e/year)

$BE_y$ : Baseline emission in year y (tCO<sub>2</sub>e/year)

$PE_y$ : Project emission in year y (tCO<sub>2</sub>e/year)

$LE_y$  : Leakage Emission in the year y (tCO<sub>2</sub>/year)

### **Baseline Emission**

As per the CDM approved Methodology ACM0002, version 21.0, Baseline emissions include only CO<sub>2</sub> emissions from electricity generation in fossil fuel fired power plants that are displaced due to the project activity. The methodology assumes that all project electricity generation above baseline levels would have been generated as existing grid-connected power plants and the addition of new grid-connected power plants.

The baseline emissions are to be calculated as follows:

$$BE_y = EG_{PJ, y} \times EF_{grid, CM, y}$$

Where;

$BE_y$  : Baseline emissions in year y (tCO<sub>2</sub>/year)

$EG_{PJ, y}$  : Quantity of net electricity generation that is produced and fed into the grid as a result of the implementation of the project activity in year y (MWh/year)

$EF_{grid, CM, y}$  : Combined margin CO<sub>2</sub> emission factor for grid connected power generation in year y (tCO<sub>2</sub>/MWh)

As per paragraph 49 of ACM0002, version-21.0, “if the project activity is the installation of a Greenfield power plant with or without the BESS, as described under paragraph 4(a) or paragraph 5(a) then:

$$EG_{PJ, y} = EG_{facility, y}$$

$EG_{PJ, y}$  : Quantity of net electricity generation that is produced and fed into the grid as a result of the implementation of the project activity in year y (MWh/year)

$EG_{facility, y}$  : Quantity of net electricity generation supplied by the project plant/unit to the grid in year y (MWh/yr)

### **Project Emission**

Since the project activity is a renewable energy project which generates electricity using solar power and hence does not result in project emissions as per the applicable methodology ACM0002, Paragraph 35, version 21.

Thus,

$$PE_y = 0.$$

The actual emission reduction achieved during the first CoU’s period as per the Project Activity:

Emission reductions for Project Activity 1:

$$ER_y = BE_y - PE_y$$

$$= (EG_{\text{facility}, y} * EF_{\text{grid}, \text{CM}, y}) - PE_y$$

$$ER_y = (33,975.20 * 0.9) - 0$$

$$ER_y = 30,577 \text{ tCO}_2$$

Emission reductions for Project Activity 2:

$$ER_y = BE_y - PE_y$$

$$= (EG_{\text{facility}, y} * EF_{\text{grid}, \text{CM}, y}) - PE_y$$

$$ER_y = (6,00,22.19 * 0.9) - 0$$

$$ER_y = 54,019 \text{ tCO}_2$$

Emission reductions for Project Activity 3:

$$ER_y = BE_y - PE_y$$

$$= (EG_{\text{facility}, y} * EF_{\text{grid}, \text{CM}, y}) - PE_y$$

$$ER_y = (1,09,230 * 0.9) - 0$$

$$ER_y = 98,307 \text{ tCO}_2$$

Emission reductions (BE<sub>y</sub>) for Entire Project Activity :

$$ER_y = BE_y - PE_y$$

$$= (EG_{\text{facility}, y} * EF_{\text{grid}, \text{CM}, y}) - PE_y$$

$$ER_y = (203,227.71 * 0.9) - 0$$

$$ER_y = 1,82,903 \text{ t}^2\text{CO}_2$$

#### Emission Reduction Per Monitoring Year:

Vintage Year	Net Generation in MWh	Grid Emission Factor	Emission Reduction(tCO2)
01/01/2017 to 31/12/2017	35682.35	0.9	32114
01/01/2018 to 31/12/2018	30042.04	0.9	27037
01/01/2019 to 31/12/2019	29055.9	0.9	26150
01/01/2020 to 31/12/2020	27216.64	0.9	24494
01/01/2021 to 31/12/2021	26393.04	0.9	23753
01/01/2022 to 31/12/2022	26120.2	0.9	23508
01/01/2023 to 31/12/2023	28717.46	0.9	25845
<b>Total</b>	<b>203227.63</b>	<b>0.9</b>	<b>182901</b>

#### C.6. Prior History>>

The project activity is a ground mounted Large -scale solar project and this project was never applied under any other GHG mechanism prior to this registration with UCR. Also, the capacity or the total project as a whole has not been applied for any other environmental crediting or certification mechanism. Hence project will not cause double accounting of carbon credits (i.e. COUs).

#### C.7. Monitoring period number and duration>>

<sup>2</sup> For conservative approach PP has taken the **1,82,901 tco2 as the emission reduction after rounding it off.**

First Issuance Period: 7 years, 00 months – 1/1/2017 to 31/12/2023.

### C.8. Changes to start date of crediting period >>

There is no change in the start date of crediting period.

### C.9. Permanent changes from PCN monitoring plan, applied methodology or applied standardized baseline >>

There are no permanent changes from registered PCN monitoring plan and applied methodology

### C.10. Monitoring plan>>

Data/Parameter	EF <sub>grid, y</sub>
Data unit	tCO <sub>2</sub> / MWh
Description	A "grid emission factor" refers to a CO <sub>2</sub> emission factor (tCO <sub>2</sub> /MWh) which will be associated with each unit of electricity provided by an electricity system. The UCR recommends an emission factor of 0.9 tCO <sub>2</sub> /MWh for the 2014- 2020 years as a fairly conservative estimate for Indian projects not previously verified under any GHG program. Hence, the same emission factor has been considered to calculate the emission reduction under conservative approach.
Source of data Value(s) applied	0.9 (UCR recommendation value ) <a href="https://a23e347601d72166dcd6-16da518ed3035d35cf0439f1cdf449c9.ssl.cf2.rackcdn.com/Documents/UCRCoUStandardAug2022updatedVer6_090822220127104470.pdf">https://a23e347601d72166dcd6-16da518ed3035d35cf0439f1cdf449c9.ssl.cf2.rackcdn.com/Documents/UCRCoUStandardAug2022updatedVer6_090822220127104470.pdf</a>
Measurement methods and procedures	-
Monitoring frequency	Ex-ante fixed parameter
Purpose of data	For the calculation of Baseline Emission

Data/Parameter	EG <sub>pi,y</sub>
Data unit	MWh
Description	Net electricity supplied to the grid by the Project activity.
Source of data Value(s) applied	Energy Meter records and/or monthly generation statement.
Measurement methods and procedures	Data Type: Measured Monitoring equipment: Energy Meters are used for monitoring Calibration frequency :once in five years(as per CEA Indian provision)

	<p>Cross checking: Quantity of net electricity supplied to or consumed at PP's facility will be cross checked from the monthly bills or invoices raised by Bangalore Electricity Supply Company Ltd (BESCOM) whichever is applicable.</p> <p>The Net electricity supplied to the grid will be calculated by the values of Electricity export to the grid. The Net electricity is recorded as following: Thus, <math>EG_{PJ,y} = EG_{Net,Export}</math></p>
Monitoring frequency	<p>The net energy exported to the grid is measured every month using calibrated energy meter by the State Electricity Board authorities in the presence of the project implementer or its representatives. The meter/s shall be jointly inspected, and sealed by authorised representatives of the company and the state utility.</p> <p>Measuring procedure: Will be measured by an export-import energy meter. The net electricity exported by the project plant would either be directly sourced as a measured parameter or be calculated by deducting the amount of imported electricity from the total amount of exported electricity.</p> <p>Accuracy class of energy meter: 0.2s Calibration Frequency: As per the Central Electricity Authority the testing and calibration frequency should be once in five years.</p>
Value applied	203,227.63
QA/QC procedures	<p>Monitoring frequency: Continuous Measurement frequency: Hourly Recording frequency: Monthly</p>
Purpose of data	Calculation of Baseline Emission

## Annex 1: Calibration Details



Plant Capacity(MW)	Location	Commissioning Date	calibration date	calibration delay	Meter Replacement
3	Village Bevinahalli , Tehsil sira, District Tumkur ,state Karnataka	23/12/2016	13/09/2021	01/01/2016 to 12/09/2021	20/03/2024
5		23/12/2016	13/09/2021	01/01/2016 to 12/09/2021	20/03/2024
10		11/01/2017	13/09/2021	01/01/2016 to 12/09/ 2021	20/03/2024

There is calibration delay for the monitoring period mentioned above in the row named as Calibration delay. The error factor has been applied in net export values for delay period as meters were not calibrated as per the calibration frequency which is once in the five years .As per the Appendix calibration of the VVS Standard v3.0,<sup>3</sup> Para 366(a), maximum permissible error can be applied, however, since no calibration has been performed after the stated dates. Error factor of "±0.2%" should be applicable for both export & import i.e. the measured values. However, net electricity generation is considered as per the registered monitoring plan, the separate export and import values are not available. Hence being conservative and to account for the error for both export & import, a cumulative error of "-0.4%" on net electricity generation has been applied for delay period. The meters were replaced on 20/03/2024 because it not functioning properly and the error was not in the permissible range which is 0.2%.

<sup>3</sup> [https://cdm.unfccc.int/sunsetcms/storage/contents/stored-file-20210921115831128/reg\\_stan06\\_v03.0.pdf](https://cdm.unfccc.int/sunsetcms/storage/contents/stored-file-20210921115831128/reg_stan06_v03.0.pdf)